

Tavoli Incas

Tables, Tische, Tables, Mesas.

v. 17077 20181108/4 - TB

p. 1/8

design Angelo Mangiarotti, 1973

Tavoli in marmo o pietra
Marble or stone tables

AINC4014072M / AINC4014040 / AINC4014072
AINC4014040M

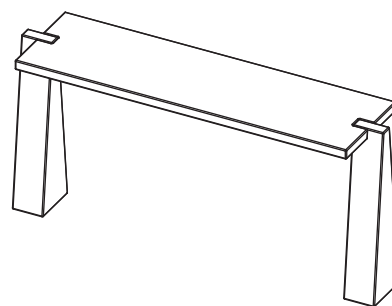

H. 72
(28" 11/32)

AINC4014072

AERO4014072M

140 (55" 1/8)

140 (55" 1/8)

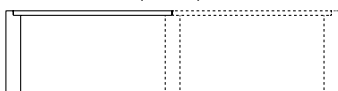
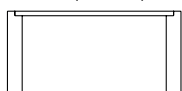

gamba/leg kg.31

gamba/leg kg. 31

H. 40
(15" 3/4)

AINC4014040

AERO4014040M



gamba/leg kg. 10

gamba/leg kg. 10

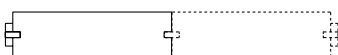

piano/top kg. 60 x3

piano/top kg. 60 x3



Personale consigliato per movimentare
gli articoli / Recommended staff to
handle the items



Rimane a discrezione dell'esecutore/installatore di applicare la normativa vigente nel proprio paese per la movimentazione dei carichi
It's up to the installer to adhere to the prescriptions/regulations existing in his country for the handling of heavy goods

AGAPE CASA

via A. Pitentino, 6
46037 Governolo
Roncoferraro
Mantova - Italia

tel.+39 0376 250 311
fax.+39 0376 250 330
info@agapecasa.it
agapecasa.it

Cura e Manutenzione

Maintenance and Care.

Tavoli Incas
Incas tables

design Angelo Mangiarotti, 1973

Marmo / Marble

Per superfici levigate e opache:

Si consiglia la manutenzione ordinaria di questi prodotti con il prodotto "Filarefresh", detergente protettivo. Utilizzato quotidianamente deterge le superfici e rafforza il trattamento protettivo antimacchia.

Prodotto neutro ideale anche per le superfici in pietra naturale più delicate. (Facile da usare, pronto all'uso, non necessita di risciacquo, rapida asciugatura, profumazione gradevole e certificato per il contatto alimentare).

Applicazione: Spruzzare Filarefresh sulla superficie e passare con un panno morbido e asciutto, massaggiare la superficie fino a completa asciugatura. Non risciacquare.

Per superfici lucide:

La manutenzione ordinaria di questi prodotti va fatta con detergenti neutri, intervallando l'utilizzo di "Formula marmo", crema polish per marmo di Fila. Questo prodotto, pronto all'uso, protegge e pulisce le piccole superfici in marmo, rimuove i residui calcarei lasciati dall'acqua e restituisce brillantezza alle superfici lucide consumate.

Applicazione: Agitare prima dell'uso. Versare su un panno e passare sulla superficie da pulire. Insistere per pochi secondi fino alla completa asciugatura.



Tutti i prodotti Agapecasa sono progettati e realizzati per uso interno. Non possono essere collocati all'esterno se non diversamente indicato.

I tavoli in pietra Serena possono essere utilizzati anche all'esterno.

For smooth and opaque surfaces:

We recommend routine maintenance of these products with the product "Filarefresh" protective detergent. For daily use, it cleans the surfaces and strengthens stain-resistant treatment.

It's a neutral product also ideal for delicate natural stone surfaces. (Easy to use, ready to use, no rinse, quick drying, pleasing scent and certified for food contact).

Application: Spray Filarefresh on the surface and pass with a soft, dry cloth, massage the surface until completely dry. Do not rinse.

For shiny surfaces:

Ordinary maintenance of these products has to be done with neutral detergents, employing every now and then "Marble Formula", a polish cream for marble by Fila. This product, ready to use, protects and cleans the small marble surfaces, removes the limestone residues left by the water and gives back shining effect to the marble surfaces.

Application: Shake before using. Pour on a cloth and pass on the surface to be cleaned. Insist for a few seconds until fully dry.

All Agapecasa products are designed and manufactured for internal use. They cannot be placed outside unless otherwise indicated.

The tables made from Extraforte are also suitable for outdoor use.

Istruzioni di Montaggio

Assembly Instructions.

p. 3/8

Tavoli Incas
Incas tables

design Angelo Mangiarotti, 1973

Contenuto della confezione
Package Contents

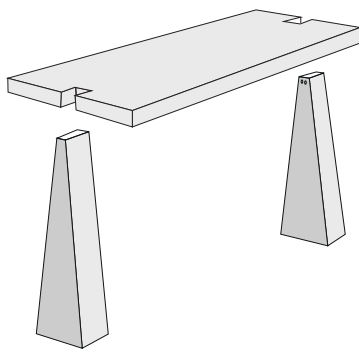

Feltri
Felt

Strumenti necessari
Required Tools

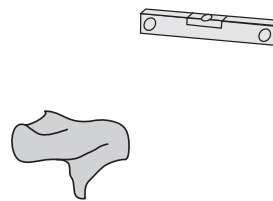

- 0.** Per applicare i feltri adesivi vedi pagina 6 e 7
To apply the felt adhesives see page 6 and 7

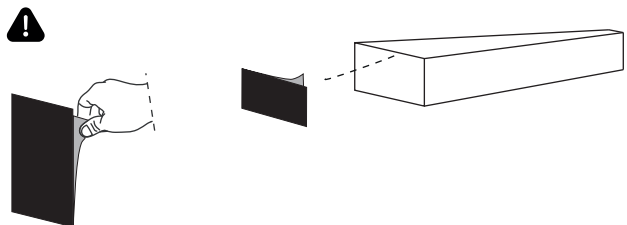

- 1.** Posizionamento dei sostegni
Placement of the legs

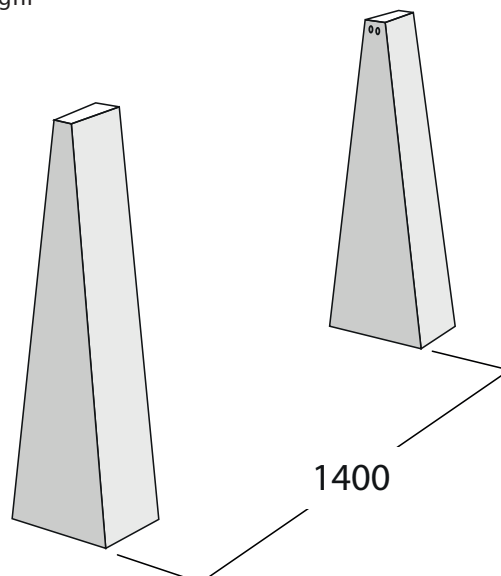

AGAPECASA

via A. Pitentino, 6
46037 Governolo
Roncoferraro
Mantova - Italia

tel.+39 0376 250 311
fax.+39 0376 250 330
info@agapecasa.it
agapecasa.it

Istruzioni di Montaggio

Assembly Instructions.

2.



Attenzione! Ogni sostegno ha il suo riferimento corrispondente alla sede del piano.

Attention! Each support has their reference, corresponding to the seat of the top.

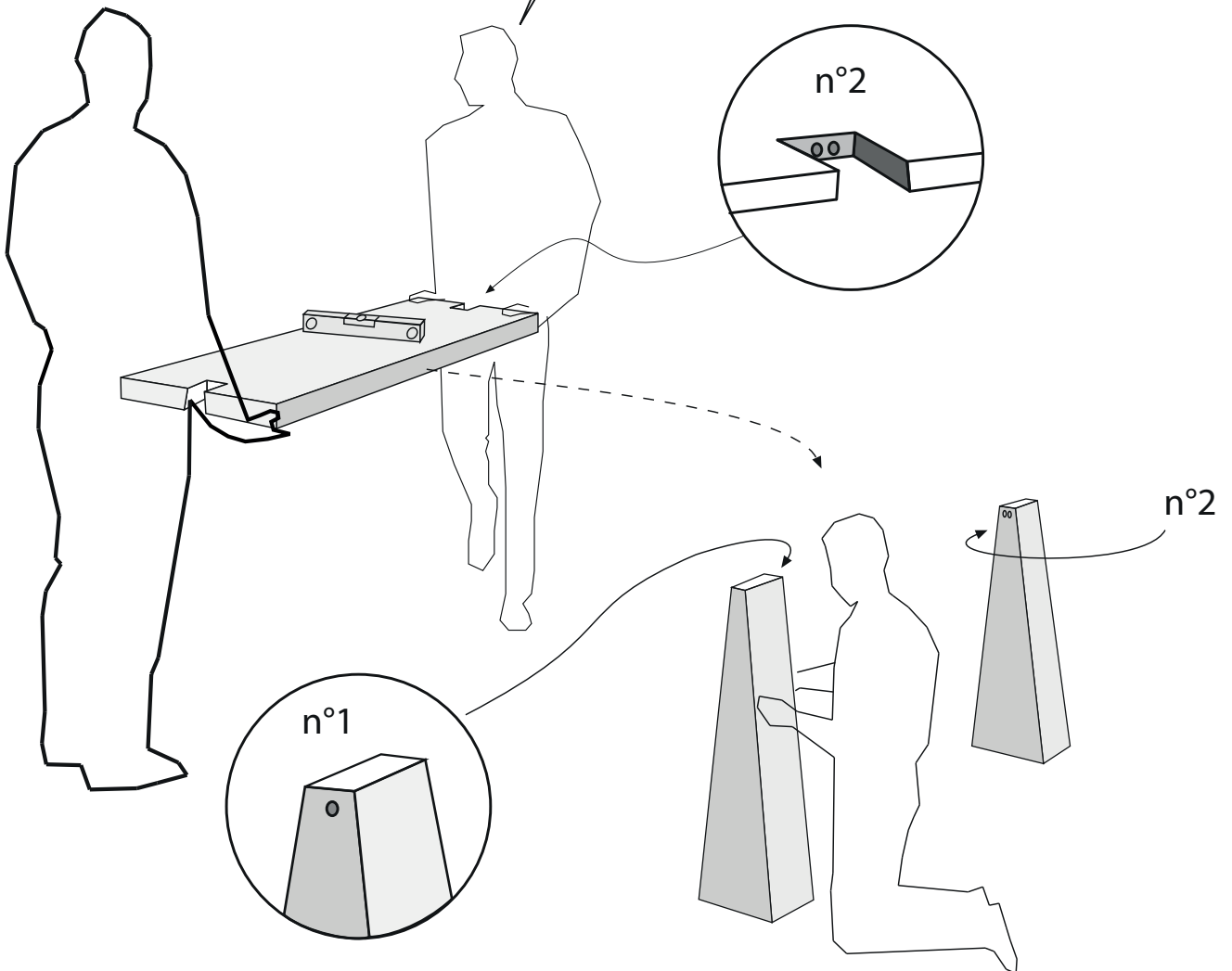
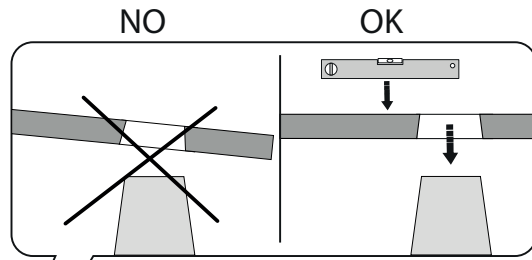

3.



Utilizzare questo tipo di montaggio solamente per le composizioni multiple con più piani (AINC401072M,AINC4014040M).

Use this type of assembly only for compositions with more plans(AINC401072M,AINC4014040M).

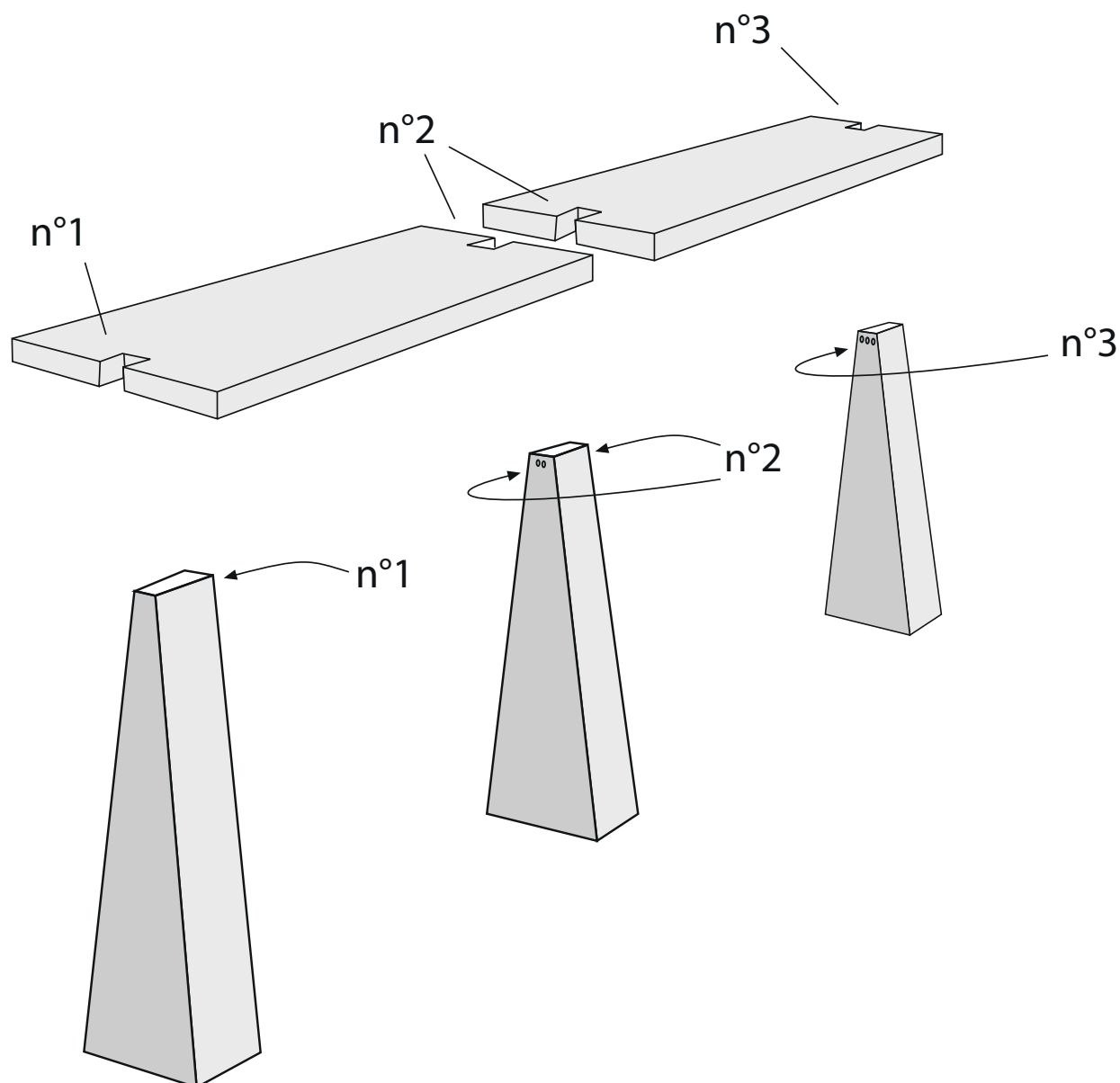

Guida movimentazione dopo installazione

Movement guide after installation



I tavoli assemblati devono essere smontati se necessario movimentarli dopo l'installazione.

Tables have to be dismantled if necessary to move them after installation.

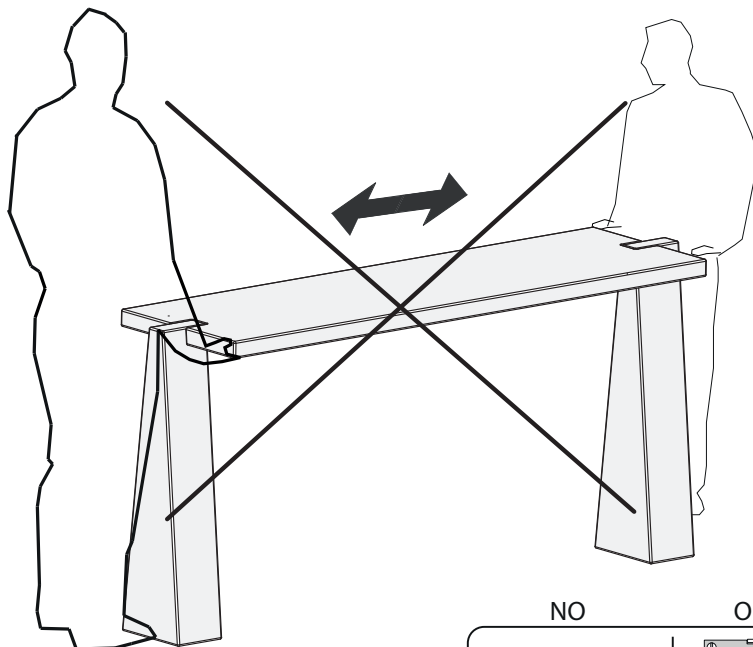

In caso di smontaggio procedere sollevando il piano mantenendolo il più parallelo possibile.

In case of disassembly proceed lifting the top keeping it as parallel as possible

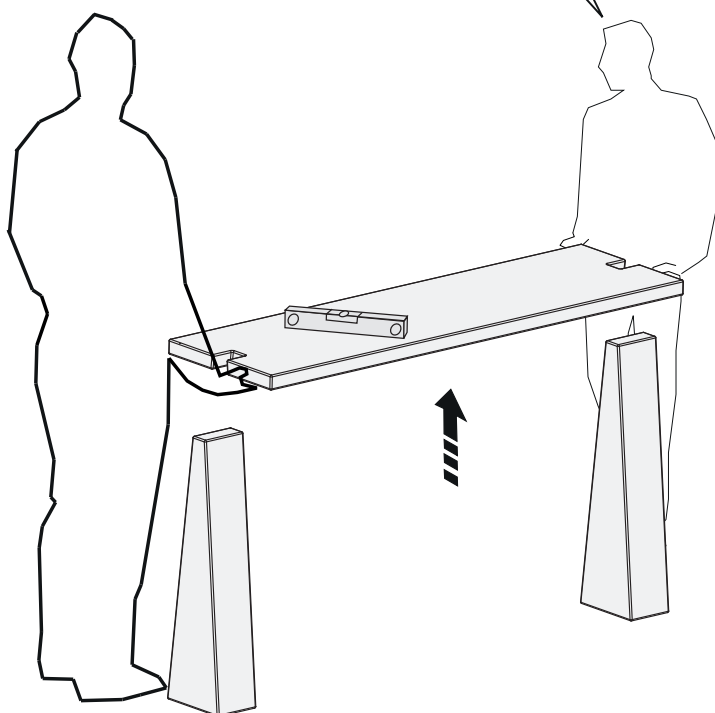
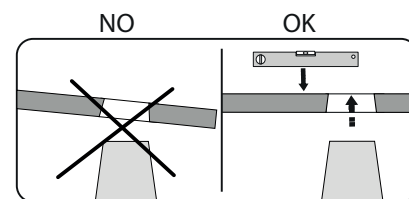

Istruzioni di Montaggio

Assembly Instructions.

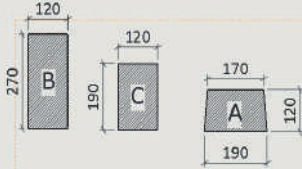
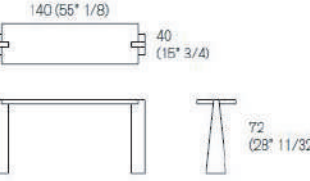
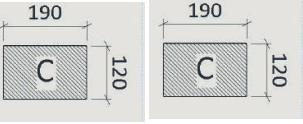
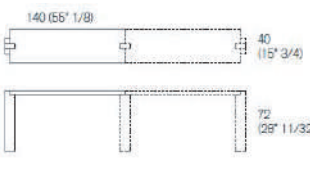
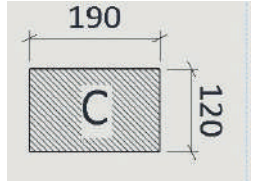
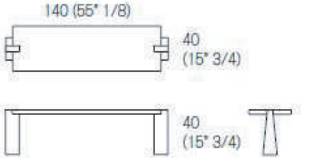
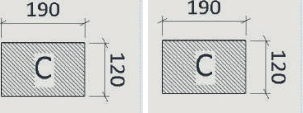
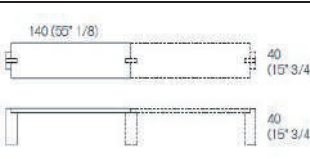
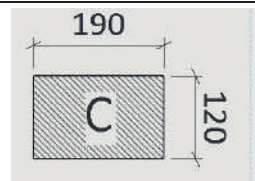
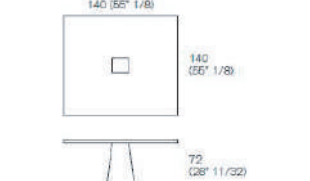
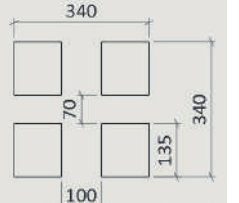
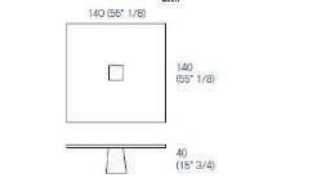
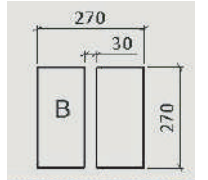
<p>CODICE</p> <p>A: PLA0739</p> <p>B: PLA0728</p> <p>C: PLA0729</p> 	<p>COD. TAVOLO</p> <p>COD. TABLE</p>	<p>COD. FELTRO</p> <p>COD. FELT</p>	<p>POSIZIONE</p> <p>POSITION</p>	<p>QUANTITA'</p> <p>QUANTITY</p>
	<p>AINC</p> <p>4014072</p>	<p>.PLA0729</p>		<p>2</p>
	<p>AINC</p> <p>4014072M</p>	<p>.PLA0729</p>		<p>1</p>
	<p>AINC</p> <p>4014040</p>	<p>.PLA0729</p>		<p>2</p>
	<p>AINC</p> <p>4014040M</p>	<p>.PLA0729</p>		<p>1</p>
	<p>AINC</p> <p>14014072</p>	<p>.PLA0728</p>		<p>2</p> <p>Ricavati dal tipo B</p>
				<p>2</p>

Istruzioni di Montaggio

Assembly Instructions.

	AINC	9022072	.MOBINCE72	.PLA0729		5
	AINC	90240722	.MOBINCD72	.PLA0729		6
	AINC	90280722	.MOBINCD72	.PLA0729		6
	AINC	9022072	.LEGINCF72	.PLA0728		5
	AINC	90240722	.LEGINCG72	.PLA0728		6
	AINC	90300722	.LEGINCH72	.PLA0728		6
	AINC	90220724	.LEGINCE72	.PLA0739		4