

Tavoli Eros

Tables, Tische, Tables, Mesas.

v. 17061 20181108/4 - TB

p. 1/5

design Angelo Mangiarotti, 1973

Tavoli in marmo per interno
Marble tables for indoor

AERO10024072 / AERO14514572 / AERO14514540 /
AERO17017072 / AERO14024072 / AERO145723 /
AERO14213572 / AERO14213540

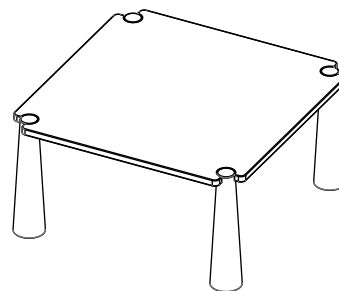

H. 72
(28" 11/32)

AERO14213572

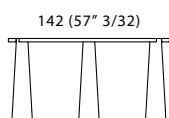

gamba/leg kg. 29

AERO14514572

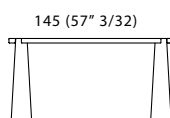

gamba/leg kg. 29

H. 40
(15" 3/4)

AERO14213540



gamba/leg kg. 12

AERO14514540



gamba/leg kg. 12

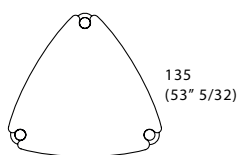

piano/top kg. 103 x4

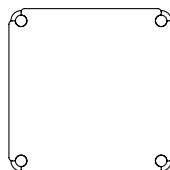

piano/top kg. 227 x8

H. 72
(28" 11/32)

AERO14024072

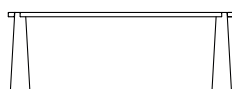

gamba/leg kg. 29

AERO17017072

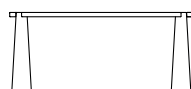

gamba/leg kg. 29

AERO145723



gamba/leg kg. 29

AERO10024072

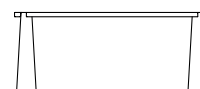

gamba/leg kg. 29

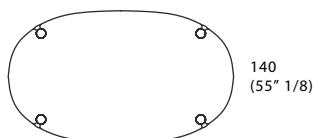

piano/top kg. 299 x11

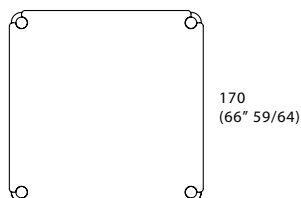

piano/top kg. 312 x11

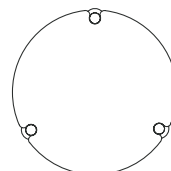

piano/top kg. 178 x7



piano/top kg. 259 x9



Personale consigliato per movimentare
gli articoli / Recommended staff to
handle the items



Rimane a discrezione dell'esecutore/installatore di applicare la normativa vigente nel proprio paese per la movimentazione dei carichi
It's up to the installer to adhere to the prescriptions/regulations existing in his country for the handling of heavy goods

AGAPECASA

via A. Pitentino, 6
46037 Governolo
Roncoferraro
Mantova - Italia

tel.+39 0376 250 311
fax.+39 0376 250 330
info@agapecasa.it
agapecasa.it

Cura e Manutenzione

Maintenance and Care.

p. 2/5

Tavoli Eros
Eros tables

design Angelo Mangiarotti, 1973

Per superfici levigate e opache:

Si consiglia la manutenzione ordinaria di questi prodotti con il prodotto "Filarefresh", detergente protettivo. Utilizzato quotidianamente deterge le superfici e rafforza il trattamento protettivo antimacchia.

Prodotto neutro ideale anche per le superfici in pietra naturale più delicate. (Facile da usare, pronto all'uso, non necessita di risciacquo, rapida asciugatura, profumazione gradevole e certificato per il contatto alimentare).

Applicazione: Spruzzare Filarefresh sulla superficie e passare con un panno morbido e asciutto, massaggiare la superficie fino a completa asciugatura. Non risciacquare.

Per superfici lucide:

La manutenzione ordinaria di questi prodotti va fatta con detergenti neutri, intervallando l'utilizzo di "Formula marmo", crema polish per marmo di Fila. Questo prodotto, pronto all'uso, protegge e pulisce le piccole superfici in marmo, rimuove i residui calcarei lasciati dall'acqua e restituisce brillantezza alle superfici lucide consumate.

Applicazione: Agitare prima dell'uso. Versare su un panno e passare sulla superficie da pulire. Insistere per pochi secondi fino alla completa asciugatura.



Tutti i prodotti Agapecasa sono progettati e realizzati per uso interno.
Non possono essere collocati all'esterno se non diversamente indicato.

For smooth and opaque surfaces:

We recommend routine maintenance of these products with the product "Filarefresh" protective detergent. For daily use, it cleans the surfaces and strengthens stain-resistant treatment.

It's a neutral product also ideal for delicate natural stone surfaces. (Easy to use, ready to use, no rinse, quick drying, pleasing scent and certified for food contact).

Application: Spray Filarefresh on the surface and pass with a soft, dry cloth, massage the surface until completely dry. Do not rinse.

For shiny surfaces:

Ordinary maintenance of these products has to be done with neutral detergents, employing every now and then "Marble Formula", a polish cream for marble by Fila. This product, ready to use, protects and cleans the small marble surfaces, removes the limestone residues left by the water and gives back shining effect to the marble surfaces.

Application: Shake before using. Pour on a cloth and pass on the surface to be cleaned. Insist for a few seconds until fully dry.

All Agapecasa products are designed and manufactured for internal use.
They cannot be placed outside unless otherwise indicated.

AGAPECASA

via A. Pitentino, 6
46037 Governolo
Roncoferraro
Mantova – Italia

tel.+39 0376 250 311
fax.+39 0376 250 330
info@agapecasa.it
agapecasa.it

Istruzioni di Montaggio

Assembly Instructions.

p. 3/5

Tavoli Eros
Eros tables

design Angelo Mangiarotti, 1973

Contenuto della confezione
Package Contents

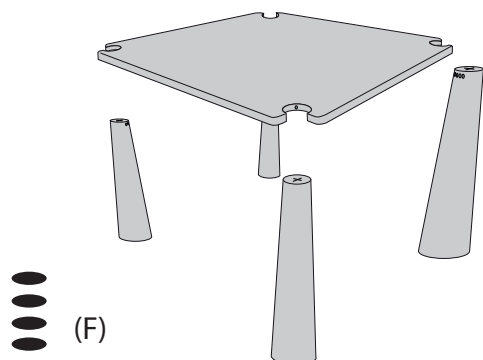

Strumenti necessari
Required Tools

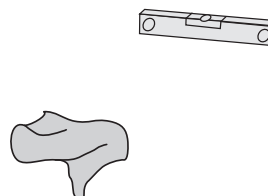

- 0.** Per pavimenti con Moquette o su tappeti i feltri adesivi (F) non vanno applicati
With carpet or carpet floors, adhesive felts (F) should not be applied

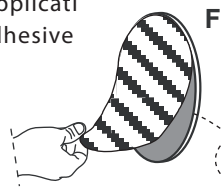

- !** Pulire la superficie
Clean the surface

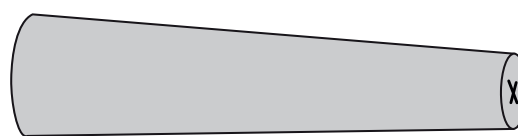

- 1.** Posizionamento dei sostegni
Placement of the legs

Misure per il posizionamento (mm)
Measurements for placement (mm)

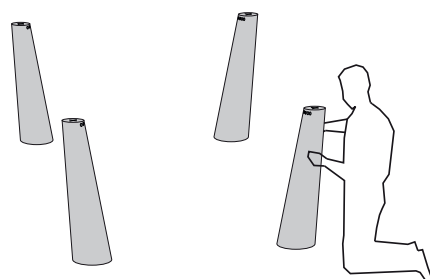
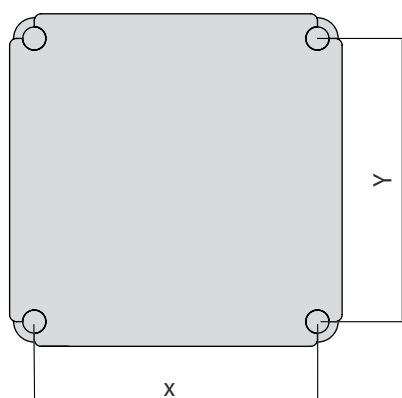

Codice Code	Dim. tavolo Table size	X	Y
AERO14213572	142 x 135	1200	1200
AERO14213540	142 x 135	1200	1200
AERO17017072	170 x 170	1485	1305
AERO14514572	145 x 145	1235	1235
AERO14514540	145 x 145	1235	1235
AERO14024072	240 x 140	1706	922
AERO145723	∅ 145	1117	-
AERO10024072	240 x 100	2185	785

AGAPECASA

via A. Pitentino, 6
46037 Governolo
Roncoferraro
Mantova - Italia

tel.+39 0376 250 311
fax.+39 0376 250 330
info@agapecasa.it
agapecasa.it

2.

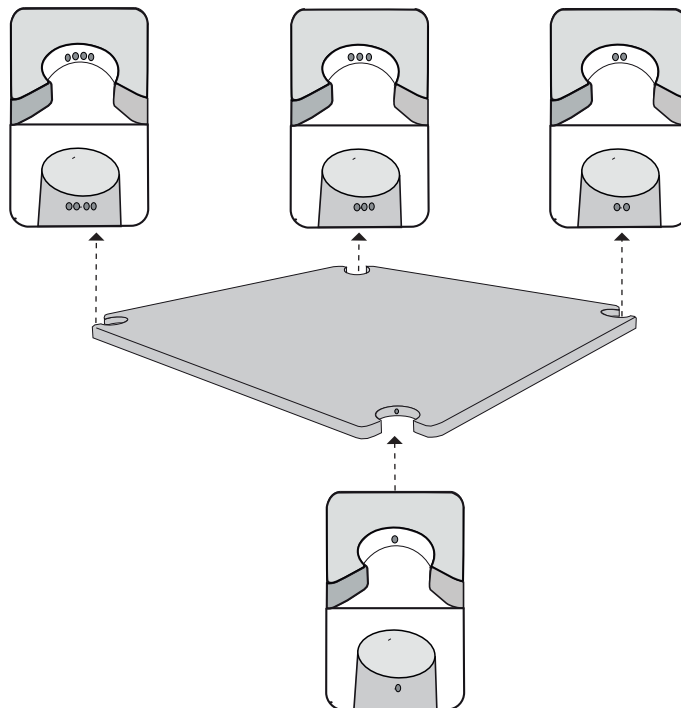

Attenzione! Ogni sostegno ha il suo riferimento corrispondente alla sede del piano.

Attention! Each support has their reference, corresponding to the seat of the top.

3.

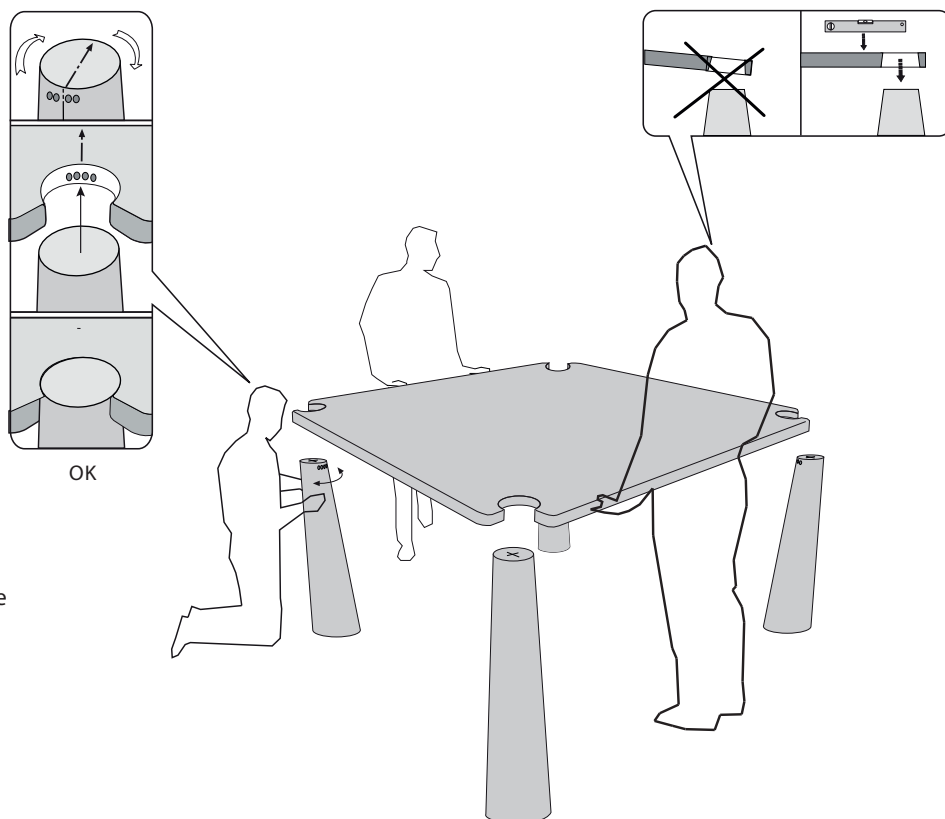

Lentamente, ruotare e accoppiare i segni
Ripetere l'operazione con gli altri supporti

Slowly rotate and match the marks
Repeat the operation with the others legs.

Il numero di persone raffigurate nell'immagine sono solo a scopo rappresentativo, vedere pag. 1 per il numero di persone consigliato
The number of people depicted in the image are for representative purposes only, see page 1 for the recommended number of people

Guida movimentazione dopo installazione

Movement guide after installation



I tavoli assemblati devono essere smontati se necessario movimentarli dopo l'installazione.

Tables have to be dismantled if necessary to move them after installation.

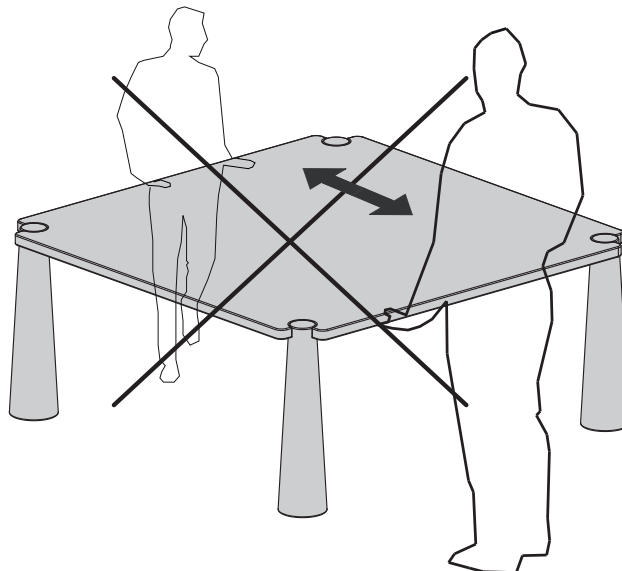

In caso di smontaggio procedere sollevando il piano mantenendolo il più parallelo possibile.

In case of disassembly proceed lifting the top keeping it as parallel as possible.

